

Mini Washing Machine

User's manual

Haier

This manual is for
HWM20-0701

- Please read this manual carefully before using.
- Retain it for future reference.



0030807846A



Contents

Names of the parts.....	1
Safety precautions	2
Installation and adjustment	4
Preparation before washing	5
The musts in washing	6
Usage of the detergent.....	6
Process washing.....	7
Disposal after washing	8
Trouble shooting	9
Packing list *Specification.....	10

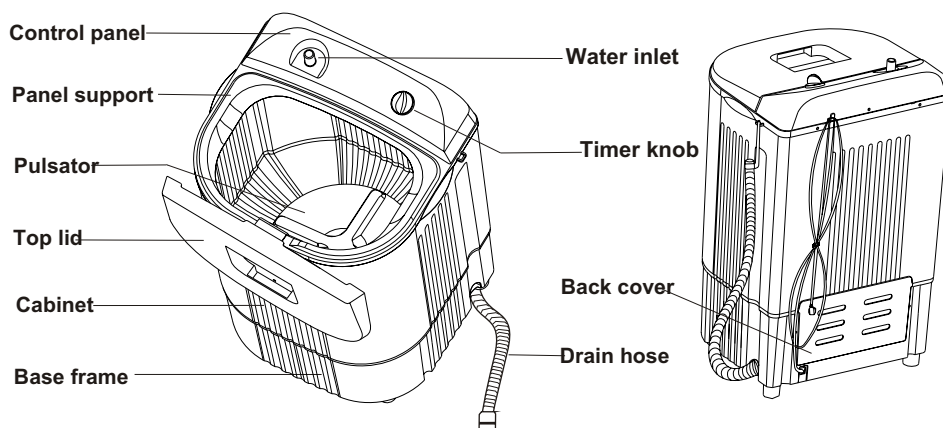
Names of the parts



Meaning and description of the symbols

<p>Warning sign</p> 	<p>Contents marked with that symbol are related to the safety of the product and the personal safety of the users. Please operate in strict conformity to the contents, otherwise it may cause damage of the machine or injure the personal safety of the user.</p>
<p>Forbidding sign</p> 	<p>Contents marked with that symbol are actions forbidden to perform. Performing of those actions may result in damage of the machine or injure the personal safety of the user.</p>

Please check if the power receptacle has good earthing condition before using to guarantee your safety.

Safety precautions

Please insert the power cord into special receptacle with rated voltage. Be sure to use single-phase three pins receptacle. The earthing terminal of the receptacle must be earthed reliably. If possible, please adopt electric leakage protector.



When the machine is normally using, please put the power plug at the location easily to be inserted and extracted by hand. Be sure to pull the plug off when there's power failure, or the machine is being moved, cleaned or when it is idle.



If the power cord is bad, to avoid risk it is required to replace it by the technicians of our special shop or the after-sale service department. Keep the pin of the power plug clean.



Do not put the machine at damp place like the bathroom. Never wash it with water. Do not place wet laundries on the control panel.



Do not use water hotter than 50°C.



In case the washing machine is installed on ground with carpet, do not block the ventilation hole with carpet.

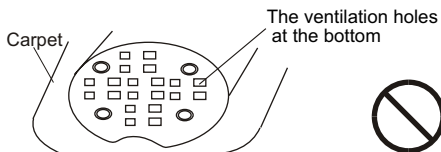

Do not wash water-proof laundries like the raincoat, bike covers etc. to avoid abnormal vibrations in spinning.



Do not let the machine share one receptacle with other electric appliances. If the power plug is damaged, or the plugging into the receptacle is loose, do not use the plug any more.

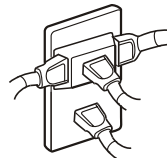

Safety precautions

Do not stretch hands into the working machine. It is dangerous even if the rotation is slow. Take special care of the children.



Do not decompose, repair or alter the machine by yourself.

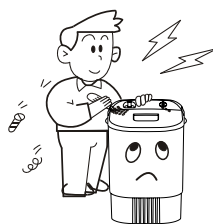

Do not put any hot or heavy items (such as the kettle with hot water) on the washing machine.

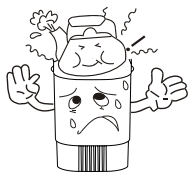

Do not wash laundries with volatile materials (such as thinner, petrol etc.)

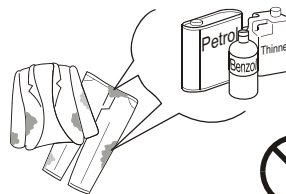

Handicapped or children without care shall not use the machine.

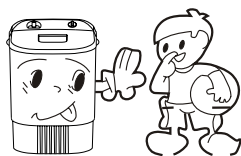

Keep the machine away from direct sunlight and heat source like the heater.

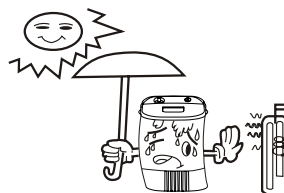

- To protect your laundries and washing machine, please take out all of the coins, buttons, sand, hairpin and other foreign materials before washing.



- Please check if the water faucet is open, and if the connection of the water inlet pipe is proper.
- It is suggested to use foamless washing powder.

Installation and adjustment

Please install and adjust the machine according to the requirement of the manual. It is very important to your security and correct operating the machine.

Usage of the drain hose

When washing, the drain hose must be hung up, if you want to drain, please refer to the below mention.

The drainage shall be smooth with the drain hose.

- 1.The height of the drain hose shall be less than 10cm , or the drainage will not be smooth enough and cause incomplete drainage.

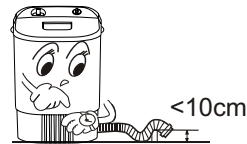

- 2.Do not step on or press the drain hose.



- 3.Suggest do not lengthen or shorten the drain hose.

Adjust the installation position



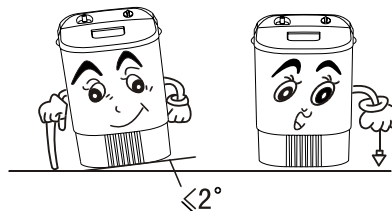

The largest permitted slope of the bearing surface of the washing machine is 2° . Slanting or uneven ground will cause unstable operation of the machine. Please check with following methods:

- Hang a becket with weight to confirm if the washing machine is horizontal.







Preparation before washing

Pay attention to followings before washing the laundries

<p>Check if the laundries has special requirement on washing</p>	<p>Clear the pocket. Take out the coins, sand, hairpins etc.</p> 	<p>Tie the long strips; fasten the buttons; close zippers.</p> 	<p>The quantity of the laundries shall not be too large. Stretch and loosen the laundries before putting them in the tub.</p> 	<p>When the pulsator is running, the buttons of the laundries may cause noise. For the sake of discretion, please put the laundries with buttons into other laundries.</p> 
<p>a. Please check if the laundries are applicable for washing. b. Please mend seedy clothes before washing. c. Separate those not colorfast from other laundries. d. For laundries not water absorbing, please put them into water with hands. e. For laundries with much soil, please remove the soil first. You can add detergent on the part with serious soil directly. It is much easier to remove the soil by that mean. f. For laundries likely to get lint ball or with long fiber, please first turn the inside out before putting them into the water. g. Do not put the laundries polluted with chemicals directly into the washing machine.</p>				

Reference weight of the laundries:

 <p>● pajamas (about 200g)</p>	 <p>● shirt (cotton, about 300g)</p>	 <p>● underpants (cotton, about 70g)</p>	 <p>● undershirt (cotton, about 180g)</p>	 <p>● Socks (blending, about 50g)</p>
---	---	---	---	--

The musts in washing



- The capacity of washing of the machine refers to the largest weight of the standard laundries under dry condition that can be washed in one time. Laundries quantity in one washing cycle shall be lower than the rated capacity.
- The thickness ,size , type of the cloth will influence the actual washing capacity. It is suitable to put in reasonable amount of laundries and the laundries can be turned round in washing for one time washing.

Usage of the detergent

How to use the whitener

- Fill water to decided level. Dilute the whitener with container. Pour it slowly into the washing tub.
- Avoid using whitener on laundries with color or pattern as they are prone to lose color.
- The whitener shall not touch the laundries directly.
- Refer to the user's manual for the usage and quantity of the whitener.
- For powder whitener, please dissolve it before using.

How to use the washing powder

- Direct dissolved in the machine
 - 1.Fill water to "1" water level.
 - 2.Add the power. Run for 30 seconds to dissolve it completely.
 - 3.Put in the laundries. Select suitable water level.
- The instant dissolving of the washing powder:
 - 1.Prepare warm water of 30°C and a container.
 - 2.Add the powder while stirring to fully dissolve it.
- Put in the proper quantities detergent according to the water level and the laundries quantities .
- It is suggested not to use high sudsing detergent.
- Washing powder with poor quality or long time storage maybe caked.

Process washing

1. Put into the laundry and detergent, then fill the water needed.

Install the water inlet hose

Insert the water inlet hose into the water-filling entrance on the control panel. The appliance is to be connected to the water mains using new hose-set and old hose-set should not be reused.

NOTE

1. Confirm that the drain hose is properly hanged before fill water, or the water will flow through the drain hose.
2. Inside the washing machine tubiness, It be marker reference water line "1", "2", "3" and the top water line "MAX". Not to a certainty over the mark "MAX".

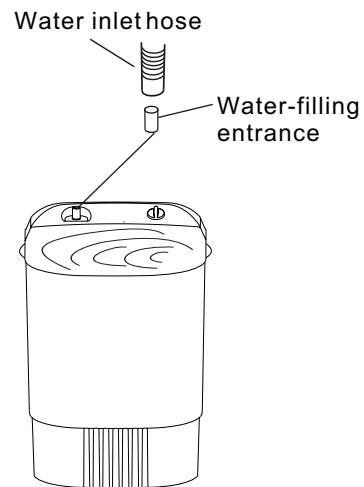

2. Close the top lid

3. Connect the powerline

Confirm that the washing machine is earthed reliably. Then insert the power plug into the receptacle. Do not connect the earth terminal to the gas pipe and tap water pipe.



4. Washing duration reference

Select washing duration depending on the laundry

Laundry	Washing Duration(min)
Silk fabric(thin laundry)	About 2~4
Knitted fabric/chemical fabric	About 3~6
Bed sheet	About 7~8
Cotton, blending or linen fabrics	About 8~10
Very dirty or heavy laundry	About 10~15

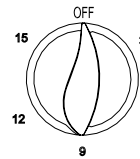

(To set to below 2 minute, first set to 6 minute then turn it back, it can increase the service life of the timer).

5. Finish washing

- The tumbler stops revolving. Level the draining hose down to let the waste water out.



Disposal after washing

- After washing, close the water faucet. (If needed, you can dismantle the water inlet hose).
- Do not store water in the washing machine for a long period. Drain the water completely after each using.
- Be sure to pull off the power plug before maintenance.
- Hang up the power cord and drain hose.
- Wipe off the water drops on the surface of the machine and inside the tub. Open the top lid for some time (about 1 hour), then close the top lid.

If the cabinet is dirty, wipe it with wet cloth

- Do not flush it directly with water.
- Wipe it with neutral detergent.
- Do not wipe it with thinner, petrol, alcohol etc.





Trouble shooting

The following phenomena are not breakdowns sometimes. Please confirm again before sending it to repair.

Phenomena	How to check
The washing machine does not act	<ul style="list-style-type: none">• Is there power failure?• Is the power plug inserted tightly?
There's abnormal sound inside the machine.	<ul style="list-style-type: none">• Is the machine slanting?• Is there metal item inside the tub?

Packing list

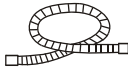
Name	Quantity
● User's manual	● One piece
● Water inlet hose 	● One piece
● Mini washing machine	● One set

Specification

Water level/Water quantity (about)	1/7L 2/12L 3/18L
Rated washing capacity(kg)	2.0
Injection pressure(MPa)	0.02~0.2